

Distr.
GENERAL

E/ESCWA/SDPD/2003/6
2 October 2003
ORIGINAL: ARABIC/ENGLISH

.....
.....
.....

.....

-

.....

-

.....

-

.....

-

.....

-

.....

-

.....

-

.....

-

.....

-

.....

-

.....

-

.....

-

.....

-

.....

-

.....

-

.....

-

.....

-

.....

-

.....

-

.....

-

.....

-

()

.....
.....
.....

-
-
-

.....

-

.....
.....
.....
.....
.....

-
-
-
-
-

.....

-

.....

.....

-

.....

-

.....

-

.....

-

.....

-

.....

-

.....

-

.....

-

.....

-

.....

-

.....

-

.....

-

.....

-

.....

-

.....

-

.....

-

.....

-

- acidogenesis
- adsorption
- aerated static pile
- airtight
- alum
- anaerobic digestion
- analog control
- anions
- anoxic processes
- antiscalant
- assimilation
- attached-growth systems
 - automatic control
 - baseline
 - belt filter press
- bicarbonate alkalinity
- biochemical oxygen demand BOD
- biological growth
- brackish water
- cations
- centrifugation
 - Centrifuge
- chemical oxygen demand COD
 - chlorides
 - Coliforms
- colloidal nature of the protoplasm
 - combined processes
 - comminution
 - composting
 - compression settling
- conceptual level estimate
 - conditioning
- constructed wetlands
 - contacting basin
- continuous systems
 - corrosion
- data acquisition systems
 - denitrification
 - dewatering

()

digestion
digital control
discrete
discrete systems
dispersants
drying
elutriation
expert systems
factorization
fecal coliforms
feedback control loops
feed-forward control loops
ferric chloride
ferric iron salts
ferric sulphate
ferrous sulphate
fiberglass
filamentous microorganisms
filter press
final clarifier
fixed volume
fixed-film reactors
flash drying
floating aquatic plants
flocculant
Flocculation
flotation
flow equalization
fluid dynamics
foaming
fouling
fuzzy control systems
gel structure
Gram-negative
granular
gravity drainage zone
grit chamber
grit removal
hindered settling

" "

()

horizontal flow
Hydrolysis
hydroxides
impaction
incineration
inclined surface
interception
internal rate of return
in-vessel composting
ion exchange
land treatment
lime
methane
methanogenesis
Microfiltration
microwave
milliamp
molecular mass
multiple-hearth drying
multiport diffuser
nanofiltration
net present value
neural networks
nitrates
nitrification
order-of-magnitude
organic polymers
Overflow
overland flow
oxidation ditch
pathogens
payback period
Phosphates
plug-flow
pollutant trading
polyelectrolytes
polymer conditioning
polystyrene
polyvinyl chloride PVC

()

pond processes
protozoa
pulse duration
Pyrolysis
rapid infiltration
Resin
reverse osmosis
rotary drying
rotating biological contactors
scaling
sedimentation
sloughing
slow rate
sludge bulking
soil matrix
solid contact
spray drying
stabilization pond
starved air
straining, screening
sulfates
Sulfides

Supervisory Control and Data Acquisition SCADA

()

surface aeration
suspended-growth systems

Thickening
tone
trace elements
trickling filter
Ultrafiltration
vacuum filter
variable volume
vertical tube reactors
wet-air oxidation
windrow

()

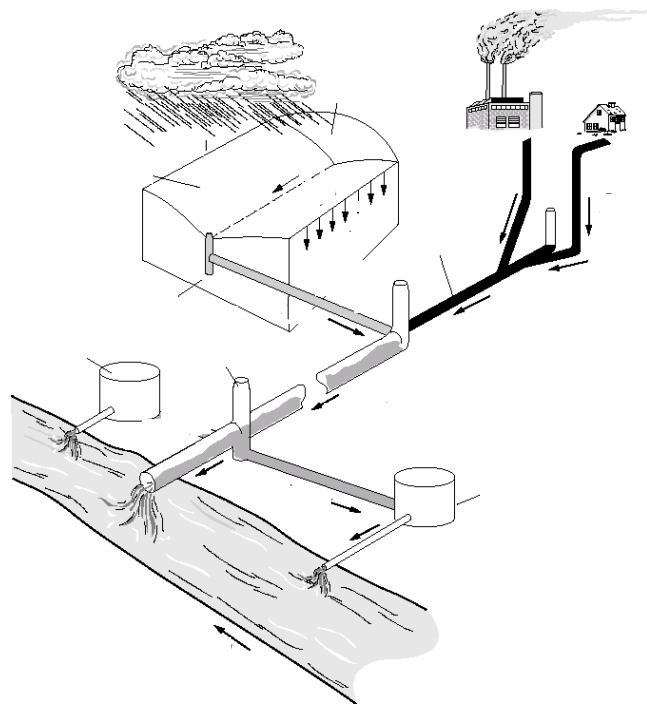

.Metcalf and Eddy, Inc., *Wastewater engineering: treatment and reuse*. 4th ed. New York, McGraw Hill, 2002 : _____

--

/ () /

()

-

. Metcalf and Eddy, Inc., *Wastewater engineering*, 3rd ed : _____

. ()
. ()

	<input type="checkbox"/>
	<input type="checkbox"/>
	<input type="checkbox"/>
	<input type="checkbox"/>
	<input type="checkbox"/>
	<input type="checkbox"/>
	<input type="checkbox"/>
	<input type="checkbox"/>
	<input type="checkbox"/>
	<input type="checkbox"/>
	<input type="checkbox"/>

	<input type="checkbox"/>
	<input type="checkbox"/>
	<input type="checkbox"/>
	<input type="checkbox"/>
	<input type="checkbox"/>
	<input type="checkbox"/>
	<input type="checkbox"/>
	<input type="checkbox"/>
	<input type="checkbox"/>
	<input type="checkbox"/>
	<input type="checkbox"/>

	<input type="checkbox"/>
	<input type="checkbox"/>
	<input type="checkbox"/>
	<input type="checkbox"/>
	<input type="checkbox"/>
	<input type="checkbox"/>
	<input type="checkbox"/>
	<input type="checkbox"/>
	<input type="checkbox"/>
	<input type="checkbox"/>
	<input type="checkbox"/>



--

--

--

- -

_____ ()

. ()
. ()

:
. ()

. ()

-

. ()
. ()

.D.H.F. Liu and B.G. Liptak. *Wastewater treatment*. Florida, Lewis, 1999

Water environment Federation (WEF) and American Society of Civil Engineers (ASCE), *Design of municipal () wastewater treatment plants (Volume 1)*, WEF Manual of Practice No.8 and ASCE Manual and Report on Engineering Practice No 76, Vermont, Book Press, Inc., 1992.

		()	
• • ○ ○ ○ ○		≥	
• • • • • •		- ,	
		, - ,	
		, - ,	

Liu and Liptak : - : _____
Water Environment Federation and American Society of Civil Engineers -

()

_____ ()

()

_____ ()

Liu and Liptak ()
()

- -

()

-

Liu and. Liptak : _____ : _____
_____ ()

-

-	-	
-	-	
-	-	
-	-	
-	-	

_____ ()

Water Environment Federation and American Society of Civil Engineers : _____

()

:

_____ (•)

()

-

Metcalf and Eddy, Inc., *Wastewater engineering*. 3rded ()

()

()

Metcalf and Eddy, Inc., *Wastewater engineering*. 3rd ed.: _____

()

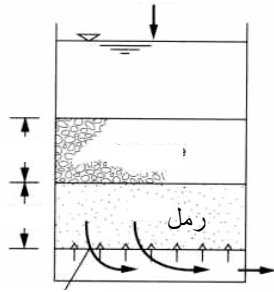

()

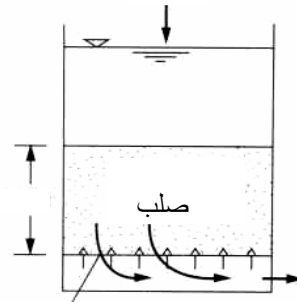

()

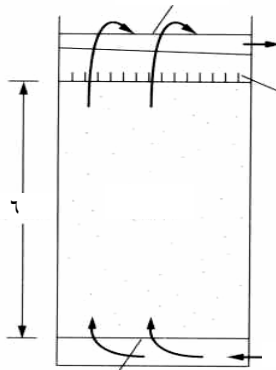

()

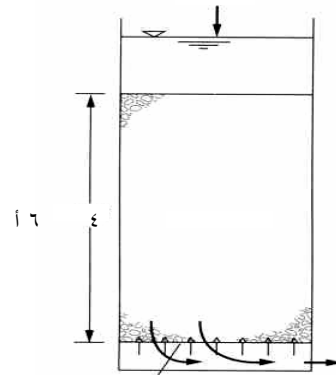

()

()

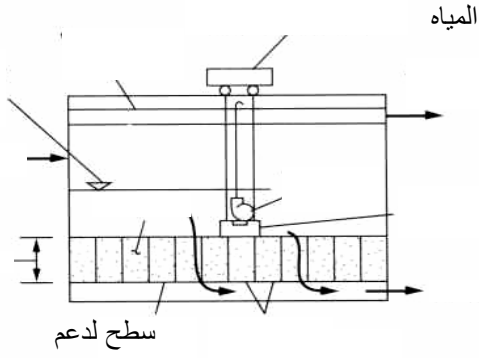

()

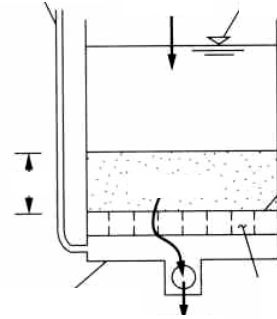

(•)

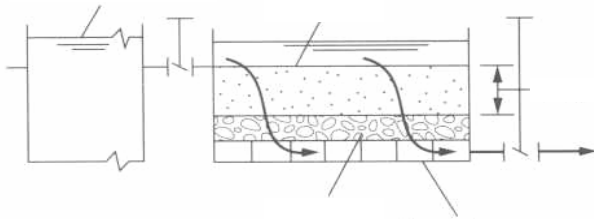

()

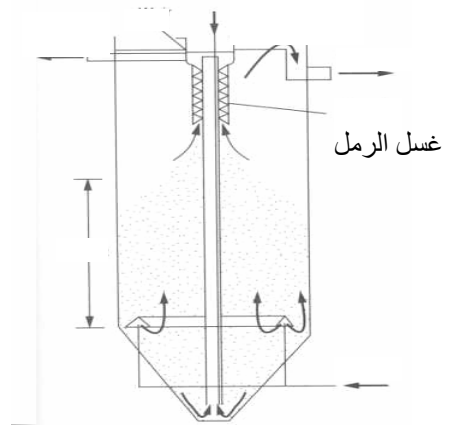

()

Metcalf and Eddy, Inc., *Wastewater engineering*, 3rd ed.:

: _____

()

()

()

		()			
		-			
		-			
		-			
		-			
		-			

- -

_____ -

_____ ()

()

()

:

()

) .

.(

_____ ()

:
() mesh

.()

()

Water Environment Federation and American Society of Civil Engineers ()

Liu and Liptak ()

Metcalf and Eddy, Inc., *Wastewater engineering*. 3rd ed. ()

()

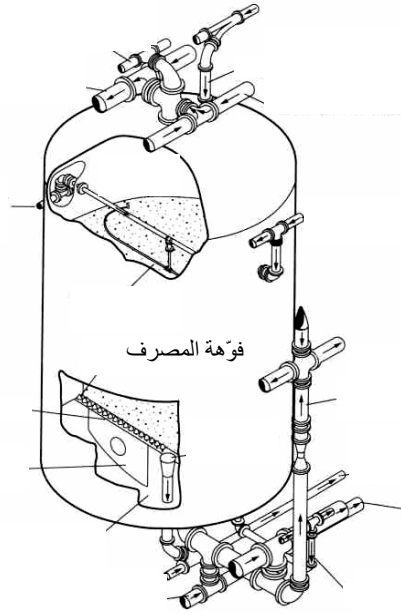

Metcalf and Eddy, Inc., *Wastewater engineering*, 3rd ed. : _____ :

_____ ()

- -

:

.

()

:

_____ ()

.

.

()

_____ -

.

.

:

.

.

.

_____ ()

()

.

.

.

.

.

Qasim ()

Qasim ()

()

()		
-)	(
-		
-		
-		(Kraus)
-		
-		
-		
-		
-		
-		
-		

()

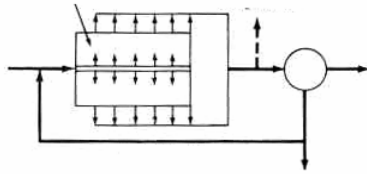

()

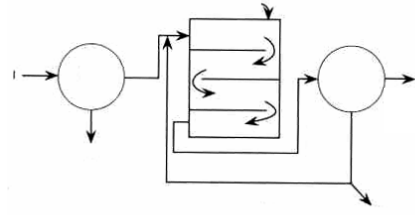

()

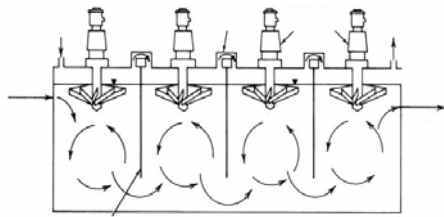

()

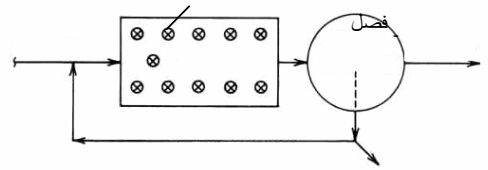

()

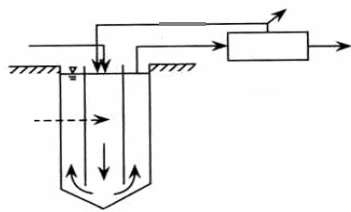

()

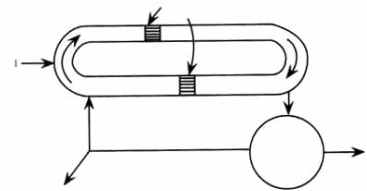

()

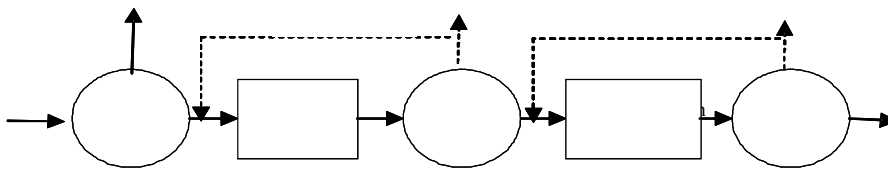

()

Liu and. Liptak : _____

Liu and. Liptak ()

_____ ()

_____ ()

()

()

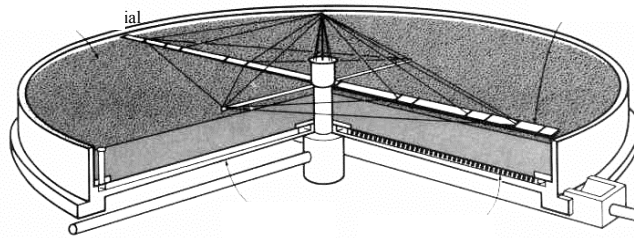

Metcalf and Eddy, Inc., *Wastewater engineering*, 3rd ed. : _____

_____ Liu and Liptak ()

- - -

_____ ()

()

()

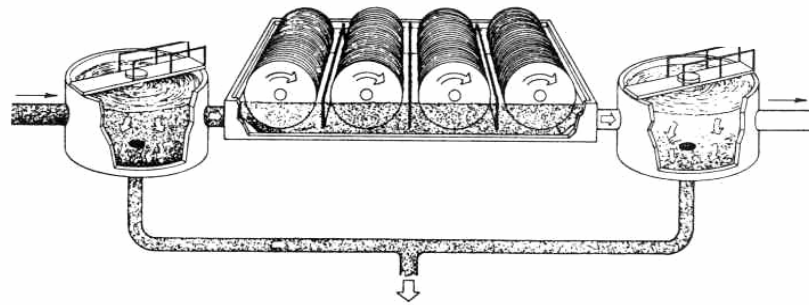

Qasim : _____

_____ (●)

()

_____ ()

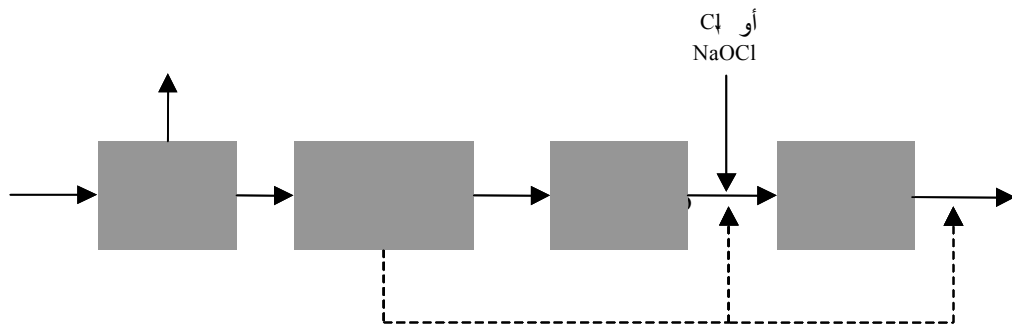

()

			- ()
			- ()

()

Metcalf and Eddy, Inc., *Wastewater engineering*. 3rd ed. : _____

_____ ()

()

_____ ()

Metcalf and Eddy, Inc., *Wastewater engineering*. 3rd ed. ()

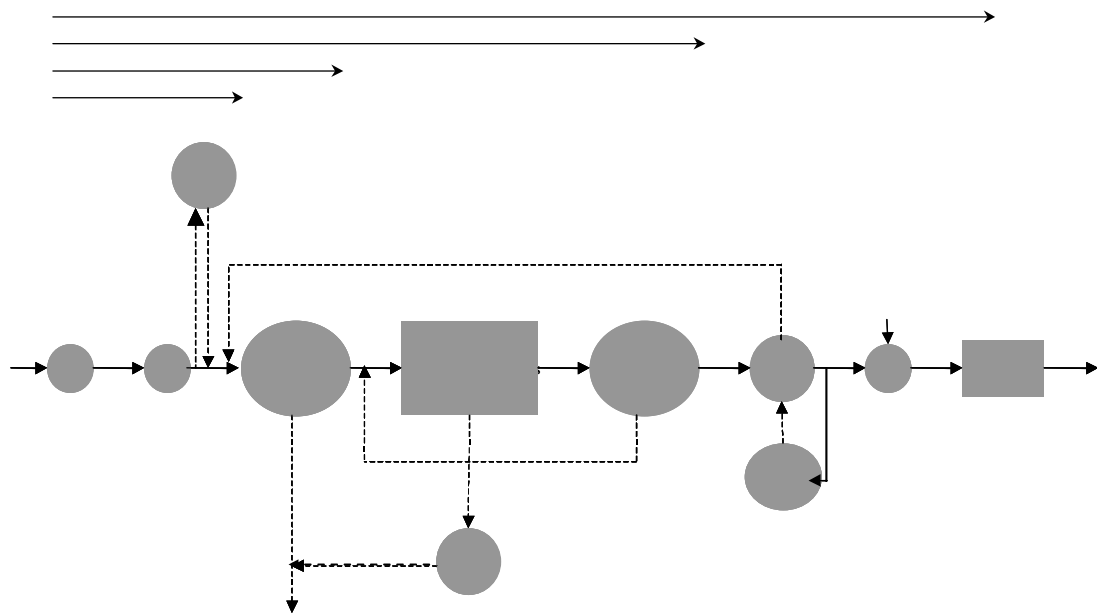

.()

- -

_____ -

_____ -

_____ -

_____ -

-

()

()

_____ -

·
·

:

_____ ()

()

:

_____ ()

.() ()

S. C. Reed, E. J. Middlebrooks and R. W. Crites, *Natural systems for waste management and treatment*. New York, ()
McGraw Hill, Inc, 1988.

Metcalf and Eddy, Inc, *Wastewater engineering*. 3rd ed.
()

Sanks, R.L., and Asano, T., *Land treatment and disposal of municipal and industrial wastewater*. Michigan, Ann - ()
Arbor Science, 1976.

Metcalf and Eddy, Inc., *Wastewater engineering*. 3rd ed. -

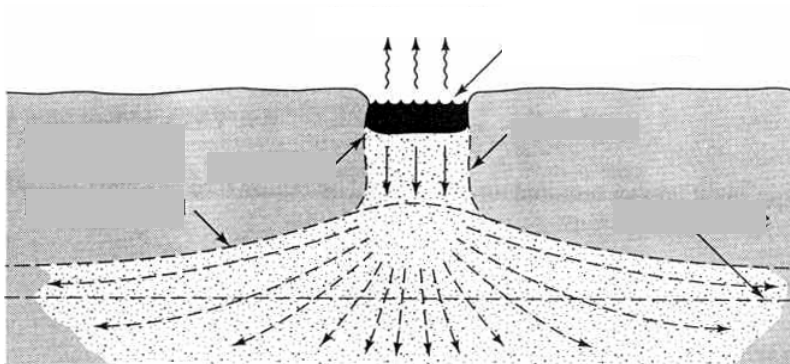

Metcalf and Eddy Inc., *Wastewater engineering*. 3rd ed. : _____

_____ ()

.(()) ()

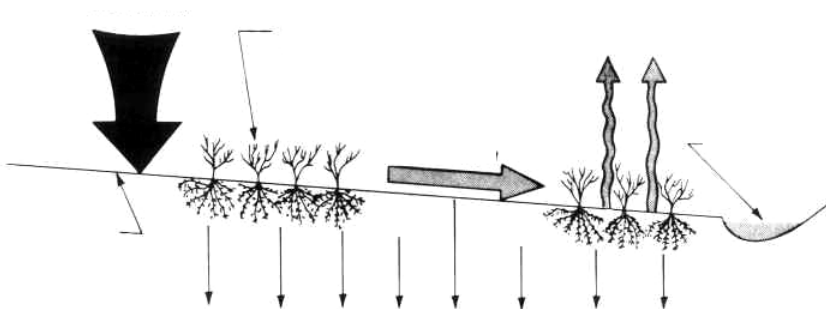

Qasim : _____

Sanks. and Asano - ()

Reed, Middlebrooks, and Crites -

- -

()

)		
			(

()

))		
		((
(/)					
-	-	<	<	<	
-	-	<	<	<	
-	-	<	, <	, <	
-	-	<	<	<	
-	-	<	<	, <	

Metcalf and Eddy, Inc., *Wastewater engineering*, 3rd ed.: _____

S. C. Reed, E. J. Middlebrooks and R. W. Crites, *Natural systems for waste management and treatment*. New York, McGraw Hill, 1988.

()

McGhee, T.J., *Water Supply and Sewerage*. New York, McGraw Hill, 1991 ()

- -

_____ -

() () () ()

Metcalf and Eddy Inc., *Wastewater engineering*, 3rd ed. : _____

_____ ()

- -
- -
_____ -

_____ ()

_____ ()

_____ ()

:()

_____ ()

_____ (•)

.(())

Liu and Liptak : _____

()

_____ Qasim ()

- -

_____ ()

- - .

. ()

_____ ()

- - -

. ()

_____ -

.
.

_____ ()

. ()

. ()

Qasim : _____

Metcalf and Eddy, Inc., *Wastewater engineering*, 3rd ed.

_____ ()

()

_____ ()

()

()

_____ ()

()

Liu and Liptak ()

Qasim ()

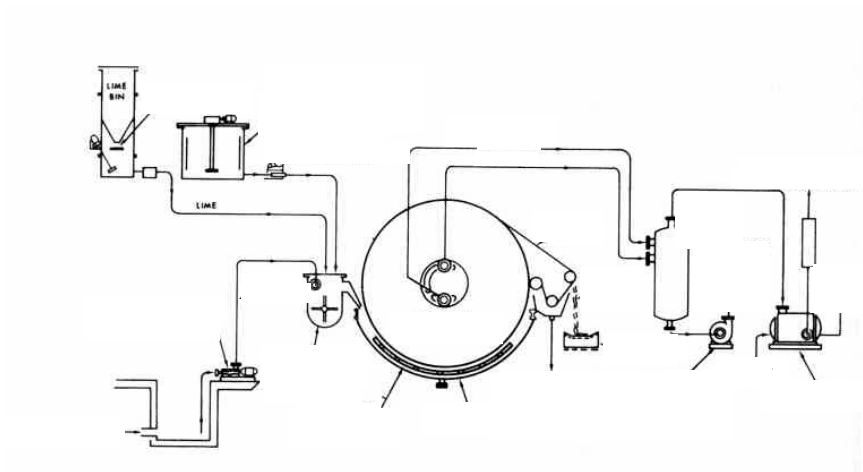

Metcalf & Eddy, Inc., *Wastewater engineering*, 3rd ed.: _____

Qasim : _____

_____ (•)

()

()

Metcalf and Eddy, Inc., *Wastewater engineering*. 3rd ed. : _____

()

Metcalf and Eddy, Inc., *Wastewater engineering*, 3rd ed. ()

()

()

-) (-) .(

Metcalf and Eddy, Inc., *Wastewater Engineering*, 3rd ed. : _____

()

.Metcalf and Eddy, Inc., *Wastewater engineering: treatment and reuse*. 4th ed. New York, McGraw Hill, Inc., 2002 ()

- -

-

-

_____ -

()

_____ -

()

_____ -

Qasim ()

.Handbook of wastewater reclamation and reuse. Boca Raton, Lewis, 1995 D.R. Rowe and I.H. Abdel-Magid ()

- -

()

()

_____ -

()

_____ -

-

()

Qasim ()

Rowe and Abde-Magid ()

Qasim ()

.R.L. Droste *Theory and practice of water and wastewater treatment*. New York, John Wiley and Sons, Inc., 1996..()

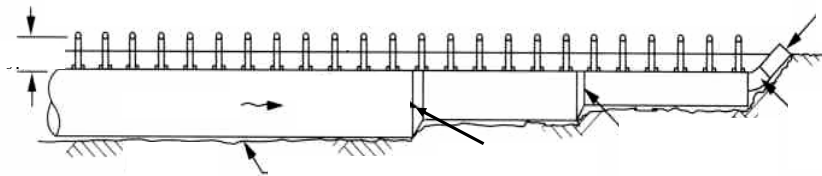

Metcalf and Eddy, Inc., *Wastewater engineering*, 3rd ed. : _____

()

Metcalf and Eddy, Inc., *Wastewater engineering*, 3rd ed. ()

National Pollutant Discharge Elimination) (NPDES

System
()

()

EC EDRWD		NPDES			
()	(/)	()			
-			/	/	
-	-		/	/	
-	-	-	-	-	
		-	-	-	
-	-	-	-	-	()
	-	-	-	-	()

United States Environmental Protection Agency, *National Pollutant Discharge Elimination System: secondary treatment* : _____
<http://cfpub.epa.gov/npdes/techbasedpermitting/sectreat.cfm> standards (2000).

World Bank, *Municipal wastewater treatment in Central and Eastern Europe: present situation and cost effective development Strategies*. The World Bank Group, Washington, D.C., 1998.

: _____

()
()
()
()

National Pollutant Discharge Elimination System: secondary treatment United States Environmental Protection Agency ()
<http://cfpub.epa.gov/npdes/techbasedpermitting/sectreat.cfm> .(standards. (2002

()

()

()

()

)

()

)

.(

()

Instrumentation in wastewater treatment facilities. Manual of practice No. 21. Virginia, Water .H. D. Gilman et al ()
Environment Federation, 1993.

Qasim ()

()

()

- -

_____ -

_____ -

/ : /)

(/

()

_____ -

_____ -

) ()

.(

Qasim ()
()

- -

-

	<input type="checkbox"/> <input type="checkbox"/> <input type="checkbox"/> <input type="checkbox"/>
(if-then)	<input type="checkbox"/> <input type="checkbox"/> <input type="checkbox"/> <input type="checkbox"/> <input type="checkbox"/> <input type="checkbox"/>
	<input type="checkbox"/> <input type="checkbox"/> <input type="checkbox"/> <input type="checkbox"/>

Qasim - : _____

Gilman -

-

()

-

Gilman ()

()

		(Parshall)	
		(Venturi)	

()

		(Venturi)	

Qasim : _____

()

()

Parshall		$\begin{aligned} & X = - \\ + & X , = - \end{aligned}$	
		$\begin{aligned} & X = - \\ + & X , = \end{aligned}$	

Qasim ()

()

		$ \begin{aligned} &+ \quad X \quad , \quad - = - \\ &\quad \quad + \quad X \quad , \\ &\quad \quad + \quad X \quad , \quad = - \\ &)/ \quad / \quad , \quad X \quad = - \\ &\quad \quad (\end{aligned} $	
/	FeCl3	$ \begin{aligned} &X \quad , \quad + \quad X \quad , \quad = - \\ &\quad \quad \quad \quad \quad \quad \quad \quad + \\ &\quad \quad \quad \quad \quad \quad \quad \quad + \quad X \quad , \quad = - \\ &\quad \quad \quad \quad \quad \quad \quad \quad X \quad = - \\ &/ \quad / (FeCL3 \quad) \end{aligned} $	
		$ \begin{aligned} &+ \quad X \quad = - \\ &+ \quad X \quad , \quad = - \end{aligned} $	
	NH3-N	$ \begin{aligned} &\quad \quad + \quad X \quad = - \\ &\quad \quad \quad \quad \quad \quad \quad \quad X \quad = - \end{aligned} $	
		$ \begin{aligned} &\quad \quad \quad \quad \quad \quad \quad \quad X \quad = - \\ &\quad \quad \quad \quad \quad \quad \quad \quad + \quad X \quad , \quad = - \\ &)/ \quad / \quad , \quad X \quad = - \\ &\quad \quad \quad \quad \quad \quad \quad \quad (\end{aligned} $	
(,)		$ \begin{aligned} &\times \quad , \quad + \quad \times \quad , \quad - = - \\ &\quad \quad \quad \quad \quad \quad \quad \quad \quad \quad \quad \quad \quad \quad + \\ &\quad \quad \quad \quad \quad \quad \quad \quad \quad \quad \quad \quad \quad \quad + \quad X \quad = - \end{aligned} $	

()

		$\begin{aligned} x + x - &= + \\ x + x - &= - \\ // , X &= - \end{aligned}$	
		$\begin{aligned} X &= - \\ X &= - \\ // , X &= - \end{aligned}$	()
		$\begin{aligned} X + X - &= + \\ X + X - &= - \\ &+ \end{aligned}$	
		$\begin{aligned} X &= - \\ X + X - &= - \\ // () X &= / \end{aligned}$	
		$\begin{aligned} X &= - \\ X + X - &= - \\ X &= - \\ // / \end{aligned}$	
		$\begin{aligned} X + X - &= - \\ &+ \\ X + X - &= - \\ &+ \end{aligned}$	

()

		$\begin{aligned} X_{11} + X_{22} &= - \\ &+ \\ &X_{33} &= - \\ &+ X_{44} &= - \\ &)X_{55} &= - \\ &X_{66} &= - \\ &X_{77} &= - \\ &X_{88} &= - \\ &X_{99} &= - \\ &X_{100} &= - \end{aligned}$	
		$\begin{aligned} X_{11} + X_{22} &= - \\ &+ \\ &X_{33} &= - \\ &+ X_{44} &= - \\ &)X_{55} &= - \\ &X_{66} &= - \\ &X_{77} &= - \\ &X_{88} &= - \\ &X_{99} &= - \\ &X_{100} &= - \end{aligned}$	
VSS		$\begin{aligned} X_{11} + X_{22} &= - \\ &+ \\ &X_{33} &= - \\ &+ X_{44} &= - \\ &)X_{55} &= - \\ &X_{66} &= - \\ &X_{77} &= - \\ &X_{88} &= - \\ &X_{99} &= - \\ &X_{100} &= - \end{aligned}$	
		$\begin{aligned} X_{11} + X_{22} &= - \\ &+ \\ &X_{33} &= - \\ &+ X_{44} &= - \\ &)X_{55} &= - \\ &X_{66} &= - \\ &X_{77} &= - \\ &X_{88} &= - \\ &X_{99} &= - \\ &X_{100} &= - \end{aligned}$	
		$\begin{aligned} X_{11} + X_{22} &= - \\ &+ \\ &X_{33} &= - \\ &+ X_{44} &= - \\ &)X_{55} &= - \\ &X_{66} &= - \\ &X_{77} &= - \\ &X_{88} &= - \\ &X_{99} &= - \\ &X_{100} &= - \end{aligned}$	

()

		$\begin{aligned} & \times = - \\ & \times = - \\ &) \times = - \\ & / \\ & (\end{aligned}$	
FeCl3	CaO		
		$\begin{aligned} X , + X , - = - \\ + \\ X , + X , - = - \\ + \\) \times = - \\ / \\ /) \times (\\) \times (\\ (/ \end{aligned}$	
		$\begin{aligned} X , + X , - = - \\ + \\ X , + X , - = - \\ + \\) \times = - \\ / \\ /) \times (\\) \times (\\ / \\ (\end{aligned}$	
		$\begin{aligned} X = - \\ X , + X , - = - \\ + \end{aligned}$	
	-	$X , = -$	

Qasim - : _____
United States Environmental Protection Agency, Detailed costing document for the centralized water treatment industry -
= : _____
=
=
=
=

()

:

_____ -

_____ -

()

Water treatment plant design. New York, McGraw-Hill, 1990. Society of Civil Engineers American Water Works Association and American ()

()

- -

_____ -

()

_____ -

()

()

()

()

()

()

()

()

()

()

()

,	,	,	,	,	,	,	,	,	
									()
,	,	,	,	,	,	,	,	,	()
									()
,	,	,	,	,	,	,	,	,	()

G. A. Pittner, "The economics of desalination processes", in: *Reverse Osmosis: membrane technology and industrial applications* edited by Z Amjad, New York, Van Nostrand Reinhold, 1993.

()

American Water Works Association and American Society of Civil Engineers, *Water treatment plant design* ()

()

									/
									(•)
									()
									/ /
						/			()
						/			()

World Bank. "municipal wastewater treatment in Central and Eastern Europe: present situation and cost effective : _____ development strategies". The World Bank Group, Washington, D.C., 1998.

- . / / ()
- . () ()
- .() ()
- .kg SS.d/BOD5/Kg , ()
- .kg SS.d/BOD5/Kg , (•)
- . ()
- . ()
- . ()
- . ()

()

_____ ()

:

()

()

()

()

_____ ()

Elarde, J. R. and Bergman, R. A, "The cost of membrane filtration for municipal water supplies", in: *Membrane practices for water treatment*. Edited by S. J Duranceau, American Water Works Association, 2001.

Membrane filtration handbook: practical tips and hints. Osmonics, Inc., 2001 Wagner .J ()

()

_____ ()

()

/

/

x

_____ ()

()

()					
			(/)		

J.J. Schoeman. Et al., "Evaluation of reverse osmosis for electroplating effluent treatment," in: *Water Science and Technology*, Vol 25. No. 10, pp. 79-93, 1992.

()

()

()

S. Adham, J Jacangelo. and J.M. Lainé, "Characteristics and costs of MF and UF plants", *American Water Works Association Journal*, May 1996.

()

()

()

() _____ ()

() _____ ()

() _____ ()

() :

() _____ -

S. Chellam, C. Serra and M. Wiesner, "Estimating costs for integrated membrane systems" *American Water Works Association Journal*, November 1998.

()

()

()

()

Pittner ()

()
()



.Dow chemical company, Ion exchange or reverse osmosis? [http:// www.dow.com/liquidseps/design/ix_ro.htm](http://www.dow.com/liquidseps/design/ix_ro.htm) : _____

- -

_____ -

()

, ,

()

()

_____ -

)
()

(

-

) x , = () () / (

Natural systems for wastewater treatment. Manual of practice FD-16. Airlington, Virginia, .S. C. Reed et al ()
 Water Environment Federation, 1990.

United Nations Environment Programme, Sourcebook of alternative technologies for freshwater Augmentation in ()
 Latin America and the Caribbean. <http://www.unep.or.jp/ietc/Publications/techpublications/TechPub-8c/>.

()

Reed et al., *Natural systems for wastewater treatment* ()

()

	$x^{-1} x = ()$ ()	
	$x^{-1} x = ()$ ()	
.	$x^{-1} x = ()$ ()	
	$x^{-1} x = ()$ ()	
	$x^{-1} x = ()$ ()	
,	$x^{-1} x , = ()$ ()	
	$x^{-1} x , = ()$ ()	
,	$x^{-1} x , = ()$ ()	
,	$x^{-1} x , = ()$ ()	
	$x^{-1} x , = ()$ ()	
	$x^{-1} x , = ()$ ()	

()

	$X - X' = ()$ $()$	
	$X - X' = ()$ $()$	
	$X - X' = ()$ $()$	

.Natural systems for wastewater treatment S. C. Reed : _____

()

;()

()

Financing and charges for wastewater systems. Water Pollution Control Federation, American C. W. Keller et al ()
Society of Civil Engineers and American Public Works Association, Hyattsville, Maryland, 1984.

International Solid Waste Association, Sludge treatment and disposal: management approaches and experiences, ()
Environmental Issues Report No.7. Copenhagen, European Environment Agency, 1997.

()

() ()	() ()		
,	,		
,	,		
,	,		() (x , =)
,	,		() - -
,	,		(x , =)
,	,		
,	,		(x , =)
,	,		(x , =)
,	,		
,	,		
,	,		
,	,		:
,	,		(%) (%) (%) (%)
,	,		
,	,		(%) (%)
,	,		
,	,		

Qasim : _____

() : _____

S.R. Qasim
(USEPA. *Industry*. EPA 821-R-98-016. <http://www.epa.gov/ostwater/guide/cwt/final/costing.pdf> (1998).

()
()

:

()

()

() _____ ()

:

() _____ -

:

()

_____ ()

National Research Council, *Ground water recharge using waters of impaired quality*. Washington, D.C., National Academies Press, 1994. ()

United Nations Environment Programme, *Sourcebook of alternative technologies for freshwater augmentation in some countries in Asia*. <http://www.unep.or.jp/ietc/publications/techpublications/techpub-8e/>. ()

()

		()
		()
		()
		()
		()

United Nations Environment Programme, *Sourcebook of alternative technologies for freshwater augmentation in some : _____ countries in Asia.* <http://www.unep.or.jp/ietc/Publications/techpublications/TechPub-8e>.

()

$$+ , (/) + , + , + , = (\quad \quad \quad)$$

Nesaratnam : _____

()	()	
	,'	/
	,'	/
	,'	/
	,'	
	,'	
	,'	

Nesaratnam : _____

$$= : \quad . (\quad \quad \quad x \quad \quad x \quad \quad)$$

- -

()

.()

-

:

(Rock River Watershed) (Minnesota Watershed) Sagino Bay Watershed)

:

P, Faeth, Fertile ground: Nutrient trading's potential to cost-effectively improve water quality. Washington, D. C., : _____
 World Resources Institute, 2000. : _____

- -

-

.

.

.

.

.

.

.

.

.

.

.

.

.

.

.

.

.

.

.

.

.

.

.

.

Fluid Knowledge,. Background on water and wastewater industry (2000).

()

<http://www.fluidknowledge.com/waterlist/html/waterindustry.html>.

F. Bataineh, M. Najjar and S. Malkawi, *Wastewater reuse*, a paper presented at the Water Demand Management Forum, Amman, March 2002. <http://www.idrc.ca/waterdemand/docs/english/jordan.doc>.

()

Food and Agriculture Organization *Irrigation in the Near East Region in Figures*. Rome, United Nations, 1997. ()
<http://www.fao.org/docrep/W4356E/w4356e0g.htm>

Food and Agriculture Organization *Wastewater treatment and use in agriculture*, FAO Irrigation and Drainage ()
Paper 47, Rome, United Nations, 1992. <http://www.fao.org/docrep/T0551E/t0551e0b.htm#9.5> wastewater treatment and human
exposure control: kuwait.

Ministry of Environment *State of the environment report 2001*. Beirut, Government of Lebanon, 2001. ()
http://www.moe.gov.lb/ledo/soer2001pdf/chpt15_wwm.pdf

- - -

() .(

) .(

()

()

.(())

()

()

S. Myllylä, *Cairo - A mega-city and its water resources, a paper presented at the Third Nordic Conference on Middle Eastern Studies: Ethnic encounter and culture change.* Joensuu, Finland, 19-22, June 1995.

<http://www.hf.uib.no/smi/paj/myllyla.html#fn7>

()

- -

()

()

-

()

()

()

()

:

.Black and Veatch. *Gabal Al Asfar Treatment Plant*. <http://www.bbv-ltd.com/Projects/WSTD/GlobsIEIATP.htm> ()

Centre International de Hautes Etudes Agronomiques Méditerranéennes (CIHEAM), *Annual Report 2000: Development and Agri-food Policies in the Mediterranean Region*. Paris, CIHEAM, 2000. <http://www.ciheam.org/ressources/en/rapport2000/chapter8.pdf>

Q.Y. Abdul-Malik *Yemen's water resources and treated wastewater*. Sana'a, Ministry of Agriculture and () <http://www.idrc.ca/waterdemand/docs/english/yemen-english.doc> Irrigation of Yemen. n.d.

()

- -

-

)

(

Abdul-Malik, Q. Y. *Yemen's water resources and treated wastewater*. Sana'a, Ministry of Agriculture and Irrigation of Yemen. n.d. <http://www.idrc.ca/waterdemand/docs/english/yemen-english.doc>.

Adham, S., J. Jacangelo and J.M. Lainé, "Characteristics and costs of MF and UF plants", *American Water Works Association Journal*, May 1996.

American Water Works Association and American Society of Civil Engineers *Water treatment plant design*. New York, McGraw-Hill, 1990.

Balkema, A. *Sustainability criteria for the comparison of wastewater treatment technologies*. Paper prepared for the Eleventh European Junior Scientist Meeting, "The Myth of Cycles versus Sustainable Water and Material Flux Management", Wildpark Eekholt, Germany, 12-15 February 1998.

Bataineh, F., M. Najjar and S. Malkawi *Wastewater reuse*. Paper presented at the Water Demand Management Forum. Amman, March 2000.
<http://www.idrc.ca/waterdemand/docs/english/jordan.doc>.

Black and Veatch *Gabal Al Asfar Treatment Plant*.
<http://www.bbv-ltd.com/Projects/WSTD/GlobslEIATP.htm>.

Centre International de Hautes Etudes Agronomiques Méditerranéennes (CIHEAM), *Annual report 2000: development and agri-food policies in the Mediterranean Region*. Paris, CIHEAM, 2000.
<http://www.ciheam.org/ressources/en/rapport2000/chapter8.pdf>.

Chellam, S., C. Serra and M. Wiesner, "Estimating costs for integrated membrane systems" *Water Works American Association Journal*, November 1998.

Dow Chemical Company *Ion exchange or reverse osmosis* °
http://www.dow.com/liquidseps/design/ix_ro.htm.

Droste, R.L. *Theory and practice of water and wastewater treatment*. New York, John Wiley and Sons, Inc., 1996.

Elarde, J. R. and R.A. Bergman, "The cost of membrane filtration for municipal water supplies", Chapter I in: *Membrane practices for water treatment*. Edited by S. J. Duranceau. Donver, American Water Works Association, 2001.

Faeth, P. *Fertile ground: nutrient trading's potential to cost-effectively improve water quality*. Washington, D. C., World Resources Institute, 2000.

Fluid Knowledge *Background on water and wastewater Industry*. (2000).
<http://www.fluidknowledge.com/waterlist/html/waterindustry.html>.

Food and Agriculture Organization, *Wastewater treatment and use in Agriculture*.
FAO Irrigation and Drainage Paper 47. Rome, United Nations, 1992.
<http://www.fao.org/docrep/T0551E/t0551e0b.htm#9.5> wastewater treatment and human exposure control: kuwait.

_____*Irrigation in the Near East Region in Figures*. Rome, United Nations, 1997.
<http://www.fao.org/docrep/W4356E/w4356e0g.htm>

- Garrett, T.M. Jr" .Instrumentation, control and automation progress in the United States in the Last 24 Years". *Water Science and Technology*, 37, 1998, pp. 21-25.
- Gilman, H. D. et al .*Instrumentation in wastewater treatment facilities: manual of Practice* No. 21. Arlington, Virginia, Water Environment Federation, 1993.
- International Solid Waste Association, *Sludge treatment and disposal: management approaches and experiences*. Environmental Issues Series no.7. Copenhagen, European Environment Agency, 1997.
- Keller, C. W et al .*Financing and charges for wastewater systems*. Water Pollution Control Federation, American Society of Civil Engineers and American Public Works Association, Hyattsville, Maryland, 1984.
- Liu, D.H.F. and B.G. Liptak *Wastewater treatment*. Boca Raton, Florida, Lewis, 1999.
- McGhee, T.J .*Water Supply and Sewerage*. New York, McGraw Hill, 1972.
- Metcalf and Eddy, Inc ..*Wastewater engineering: treatment, disposal and reuse*. New York, McGraw Hill., 1991.
- ____, *Wastewater engineering: treatment and reuse* .New York, McGraw Hill, 2002.
- Ministry of Environment of Lebanon, *Lebanon State of the environment report 2001*. Beirut, Government of Lebanon, 2001. http://www.moe.gov.lb/ledo/soer2001pdf/chpt15_wwm.pdf.
- Ministry of Public Works of Kuwait *The Kuwait sanitary scheme*. Sanitary Engineering Department, Kuwait, 1996.
- Myllylä, S., *Cairo - a mega-city and Its water resources*. Paper presented at the Third Nordic Conference on Middle Eastern Studies: ethnic encounter and culture change. Joensuu, Finland, 19-22, June 1995. <http://www.hf.uib.no/smi/paj/myllyla.html#fn7>.
- National Research Council, *Ground water recharge using Waters of impaired quality*. Washington, D.C., National Academies Press, 1994.
- ____, *Use of reclaimed water and sludge in food crop production*. Washington, D.C., National Academies Press, 1996.
- Nesaratnam, S .*Effluent treatment*. Leatherhead, Surrey, Pira International, 1998.
- Pittner, G. A., "The Economics of desalination processes", in :*Reverse osmosis: membrane technology, water chemistry and industrial applications*. Edited by Z. Amjad. New York, Van Nostrand Reinhold, 1993.
- Qasim, S. R. et al., "Estimating costs for treatment plant construction, American Water Works Association Journal, August 1992.
- Qasim, S.R., *Wastewater treatment plants: planning, design and operation*. ^C2 ed. Lancaster, Pennsylvania, Technomic, 1999.
- Reed, S.C., Middlebrooks, E.J.and Crites, R.W .*Natural systems for waste management and treatment*. New York, McGraw Hill., 1988.

- -
- Reed, S. C., *Natural Systems for Wastewater Treatment. Manual of practice FD-16.* Arlington, Virginia, Water environment Federation, 1990.
- Rowe, D.H. and I. H. Abdel-Magid *Handbook of wastewater Reclamation and Reuse.* Boca Raton, Florida, Lewis , 1995.
- Sanks, R.L. and T. Asano *Land treatment and disposal of municipal and industrial wastewater.* Michigan, Ann Arbor Science, 1976.
- Schoeman, J.J. et al., "Evaluation of reverse osmosis for electroplating effluent treatment " *Water Science and Technology*, vol 25, no 10, 1992, pp 79-93
- United Nations Environment Programme, *Sourcebook of alternative technologies for freshwater Augmentation in Latin America and the Caribbean.*
<http://www.unep.or.jp/ietc/Publications/techpublications/TechPub -c./>
- _____, *Sourcebook of Alternative Technologies for Freshwater Augmentation in Some Countries in Asia .*
<http://www.unep.or.jp/ietc/Publications/techpublications/TechPub-8e./>
- United States Bureau of Reclamation *Water treatment estimation routine (WaTER), User manual.* August 1999.
- _____, *Detailed costing document for the centralized waste treatment industry.* EPA 821-R-98-016. Washington, D. C., 1998.<http://www.epa.gov/ostwater/guide/cwt/final/costing.pdf>.
- _____, *National pollutant discharge elimination system: secondary treatment standards.* Washington, D. C., USEPA, 2002.
<http://cfpub.epa.gov/npdes/techbasedpermitting/sectreat.cfm>.
- _____, *Estimating water treatment costs, Vol. 2, Cost curves applicable to 200 mgd treatment plants.* Washington, D. C., EPA, 1979. (EPA-600012-79-162).
- Wagner, J .*Membrane filtration handbook: practical tips and hints.* Osmonics, Inc., 2001.
- Water Authority of Jordan .*Wastewater Sector,*
<http://www.mwi.gov.jo/waj/WAJ%20Web%20Page/wastewater.htm>.
- Water Environment Federation and American Society of Civil Engineers *Design of Municipal Wastewater Treatment plants, Volume 1.* WEF Manual of Practice No.8 and ASCE Manual and Report on Engineering Practice No.76. Vermont, Book Press Inc.,1992.
- World Bank *Municipal wastewater treatment in Central and Eastern Europe: present situation and cost effective development strategies,* The World Bank Group, Washington, D.C., 1998

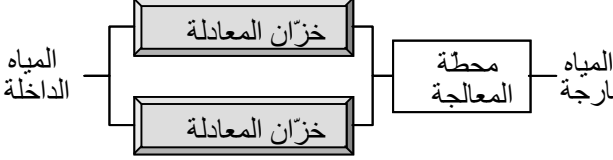
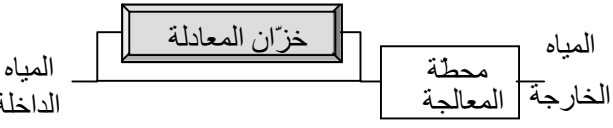
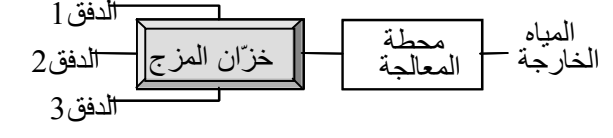
<p>المياه الداخلة</p> 		
<p>المياه الداخلة</p> 		
<p>الدفق 1 الدفق 2 الدفق 3</p> 		
<p>المياه الداخلة</p> 